

# FF85K

## Recommended Back Loaded Horn Type Enclosure

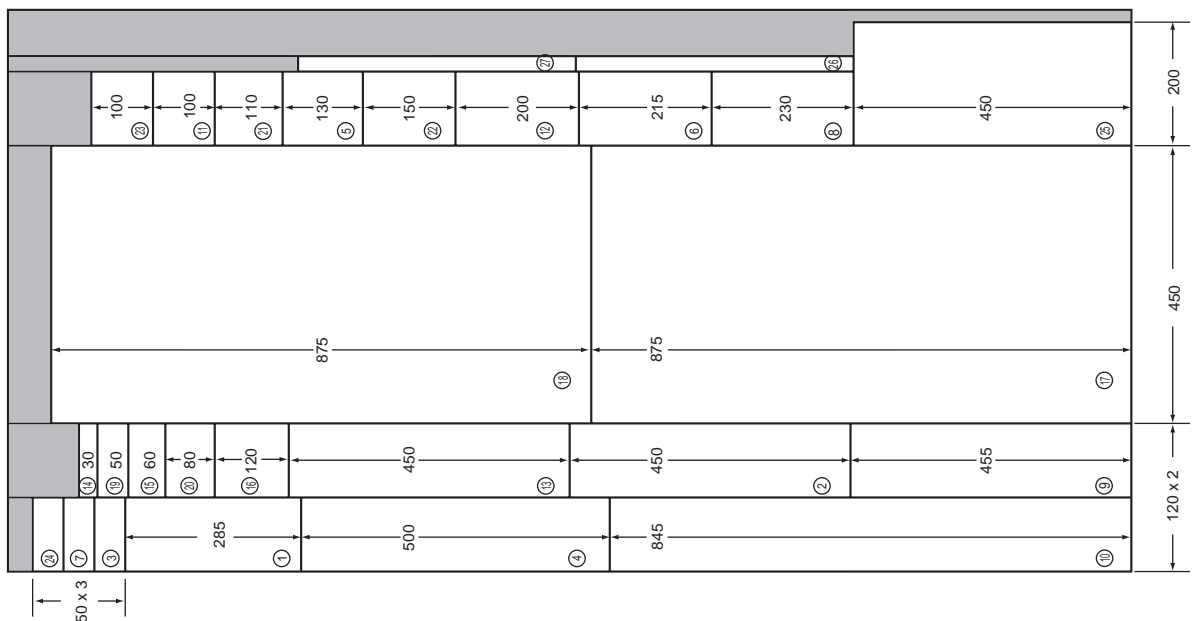

- This example is a back loaded horn type enclosure for FF85K.
- Two FF85K are used and positioned vertically for a slim enclosure and stable sound localization.
- 21mm thick plywood is used for main section and side panels to ensure a strong enclosure.
- As the shown frequency response was measured at 1 meter distance in anechoic room, a 'dip' was appeared between 100Hz and 200Hz by the interference of horn & drivers' radiation. However, there is no influence at the actual listening position.
- Units should be mounted as closely together as possible in order to avoid interference of both drivers' radiation, which generates unwanted 'dips' and 'peaks' on frequency and makes high frequency directivity worse.
- Connect both units in parallel.

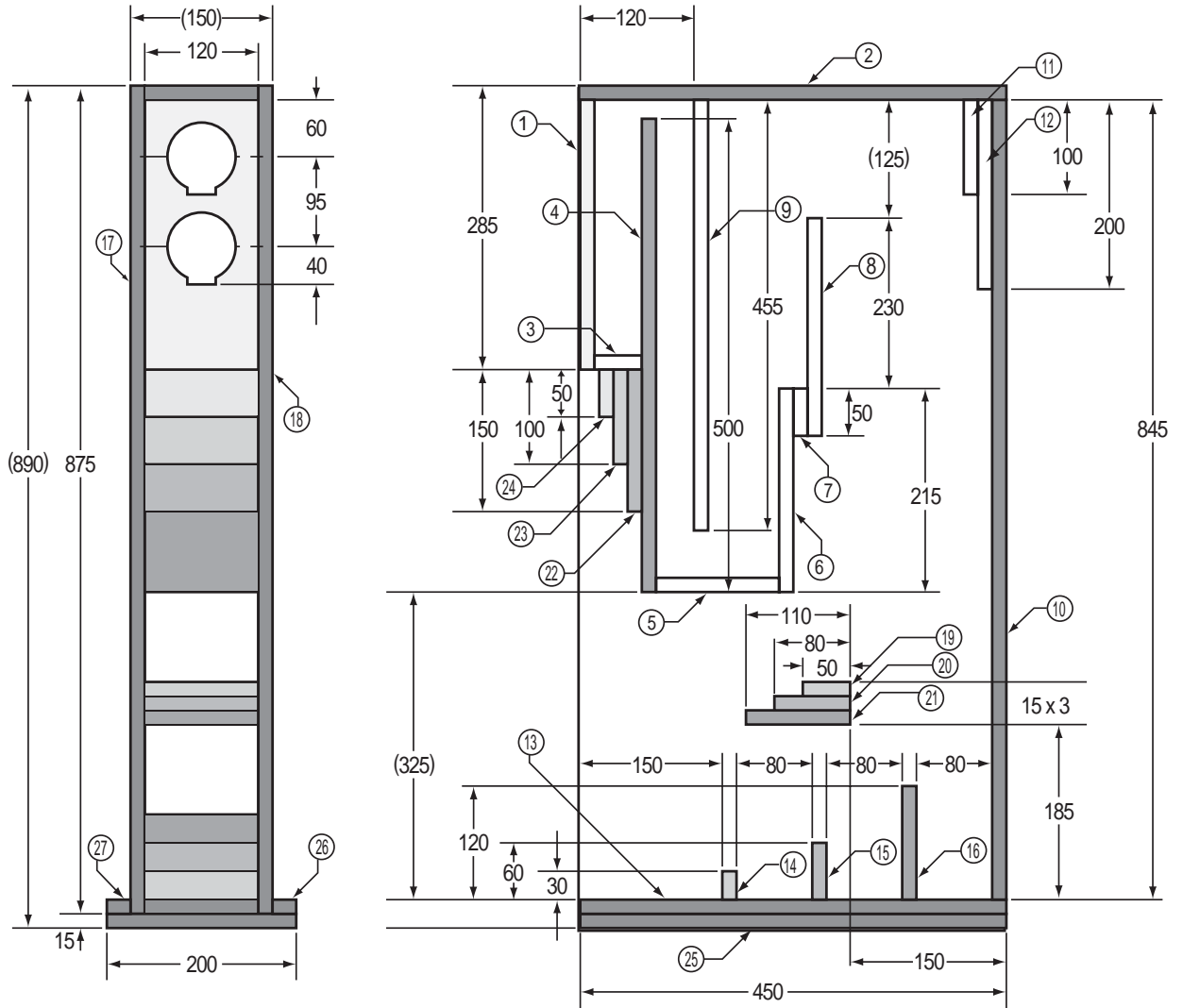
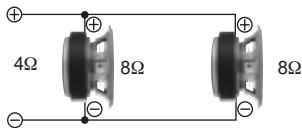
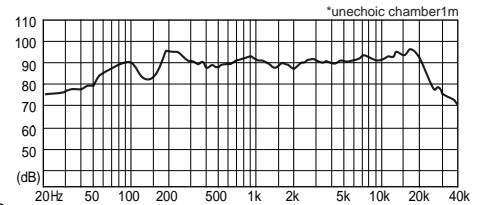

## Bass Reflex Type Enclosure

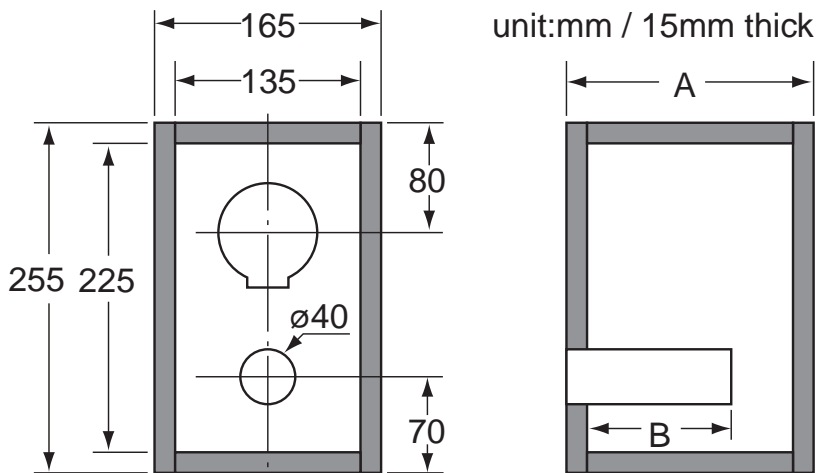

- fb=115Hz / 4.5 liters  
A=180 / B=30
- fb=75Hz / 4.5 liters  
A=180 / B=120
- fb=110 Hz / 5 liters  
A=195 / B=30

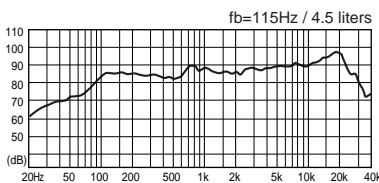

- Example 1  
A=180mm / B=30mm  
Internal capacity is 4.5 liters tuned to approximately 115Hz (Fb) for 'tight' low-frequency reproduction.

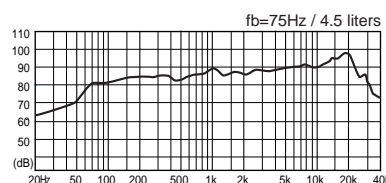

- Example 2  
A=180mm / B=120mm  
Internal capacity is 4.5 liters tuned to approximately 75Hz (Fb) for 'soft' low-frequency reproduction.

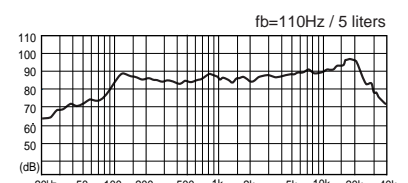

- Example 3  
A=195mm / B=30mm  
Internal capacity is 5 liters tuned to approximately 110Hz (Fb) for 'loud' low-frequency reproduction.