



FX-series

FX120

Features

- ◆ 120mm (5 in) cone type full range
- ◆ 8 ohm impedance
- ◆ fo to 20kHz frequency response
- ◆ 89dB sensitivity at 1W/1m (3.3ft)
- ◆ 1.32kg (2.910 lb) net weight

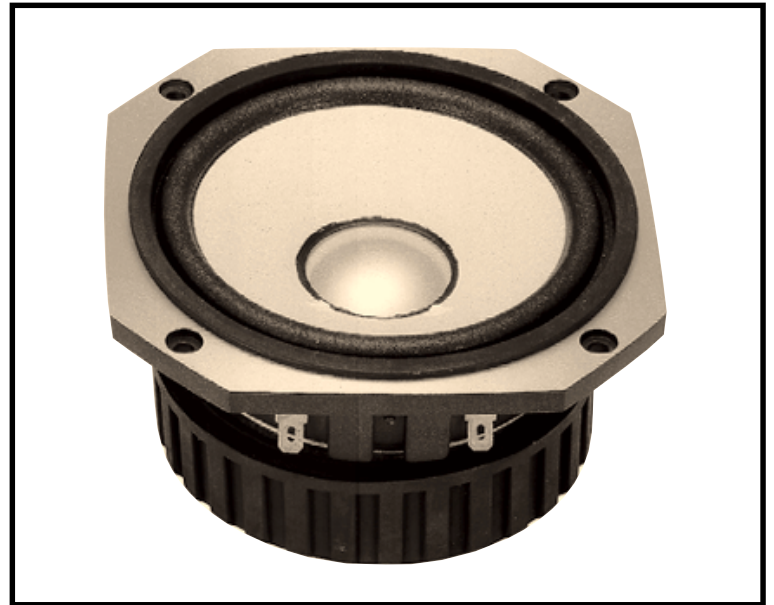

Specifications & Thiele/Small Parameters

Impedance	: 8 ohm
Minimum Frequency Response	: 65Hz
Reproduction Frequency Response	: fo - 20kHz
S.P.L.	: 89dB/W (m)
Rated Input	: 10W
Music Power	: 30W
Equivalent Diagram Radius	: 46mm (1.811 in)
Equivalent Mass	: 5.3g (0.012 lb)
Magnet Weight	: 330g (0.728 lb)
Net Weight	: 1.32kg (2.910 lb)
Fs	: 70Hz
Re	: 7.3 ohm
Qts	: 0.45
Qms	: 8.4
Qes	: 0.47
Vas	: 8.21 L
Xmax	: 2.0mm (0.079 in)
no	: 0.4%

Frequency Response / Impedance

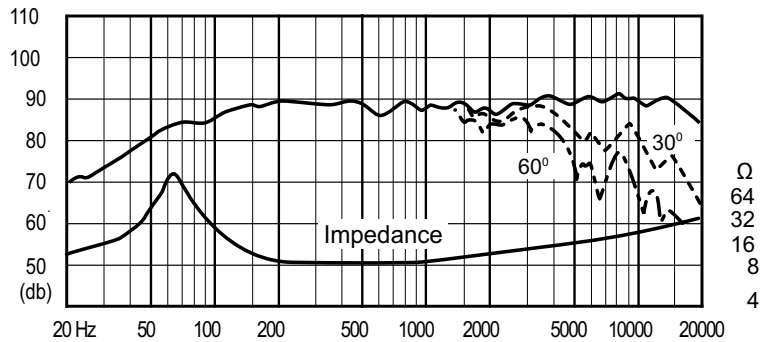

Dimensions & Mounting Information

